

# FD36UXIW



<b>Product family</b>	Refrigerator
<b>Installation</b>	Freestanding
<b>Category</b>	French-door
<b>No-frost system</b>	Yes
<b>Cooling type</b>	Total no-frost - Dual-flow cooling system
<b>Defrost</b>	Automatic
<b>Hinge</b>	Standard
<b>Counter-depth</b>	Yes
<b>EAN code</b>	8017709344016



## Aesthetic



<b>Aesthetics</b>	SPR	<b>Side color</b>	Steel
<b>Color</b>	Stainless steel	<b>Logo</b>	Applied
<b>Material</b>	Steel	<b>Door shelf profile color</b>	Silver
<b>Door stainless steel type</b>	Normal	<b>Drawers profile color</b>	Silver
<b>Handle</b>	External	<b>Glass shelf profile color</b>	Silver
<b>Handle</b>	Fixed	<b>Display</b>	LED
<b>Handle color</b>	Stainless steel	<b>Display position</b>	Internal
<b>Logo color</b>	Stainless steel	<b>Dispenser</b>	Ice and water
<b>Side material</b>	Steel	<b>Water filter</b>	Yes

## Refrigerator compartment features



<b>Number of compartments</b>	3	<b>Type of crisper cover</b>	Glass
<b>Compartment types</b>	Low temperature compartment, Fruit and vegetable compartment	<b>No. of lights</b>	4
<b>Type of adjustable shelves</b>	Glass	<b>Refrigerator lighting</b>	Yes
<b>Crisper drawer type</b>	Sliding crisper	<b>Refrigerator lighting</b>	LED
<b>Crisper cover</b>	Yes		

## Refrigerator Inner Door

Number of adjustable door shelves 2

No. of bottle shelves 2

## Other Refrigerator features



Humidity Control Yes  
Accessories Egg tray  
MultiFlow Yes

Fan Ionizer Yes  
Yes

## Freezer features

Number of drawers 2  
No. of lights 2

Freezer lighting Yes  
Freezer lighting Incandescent light

## Other Freezer features

Accessories 1 x ice box

Ice maker Automatic

## Other technical features



Display functions	Holiday, Fast-freezing, Sabbath
Fast-freezing button	Yes
Water network connection	Yes
Power-on light	Yes
Temperature alarm	Yes
Door open alarm	Yes
Temperature setting type	Electronic
No. of compressors	1
Refrigerant gas type	R600a
Compressor type	Inverter
No. of evaporators	2
Foam agent	Cyclopentane

## Performance / Energy Label

Annual energy consumption		Total volume	20.48 cu. ft.
Total volume	20.52 cu. ft.	Noise level	35 dB(A) re 1 pW
Freezer volume	6.75 cu. ft.	Freezer capacity	6.75 cu. ft.
Refrigerator compartment	13.77 cu. ft.	Refrigerator volume	13.77 cu. ft.

## Electrical Connection







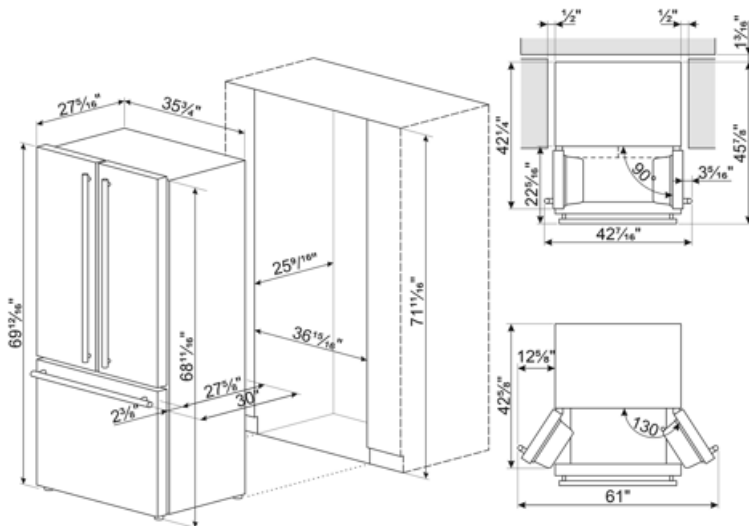



Electrical connection rating	280 W	Frequency (Hz)	60 Hz
Current	2.7 A	Power cord length	84 5/8 "
Voltage (V)	120 V	Plug	(B) NEMA 5-15P

## Logistic Information

Width	35 3/4 "	Built-in niche height	71 11/16 "
Built-in niche width	36 15/16 "	Width with doors open at 90°	41 11/16 "
Depth without handle	26 13/16 "	Product depth (handle included)	29 "
Built-in niche depth	25 "	Depth with door open at 90°	42 1/4 "
Height	69 3/4 "	Spacer depth	0 13/16 "



## Symbols glossary

	Smeg Active Ion system improves the quality of the air inside the cell. Thanks to the generation of negatively charged ions released inside the fridge Active Ion system neutralizes unpleasant dust.		The automatic defrost system works by automatically defrosting at regular intervals eliminating the need to defrost altogether.
	LED display: to show programmes, functions and options selected and the time to the end of the cycle.		Ventilated: Forced distribution of cold air in the refrigerator compartment, which allows even temperature distribution within the fridge.
	Fast freezing: The fast freezing function brings the temperature of the compartment down when activated a few hours prior to usage.		Power saving mode: The power saving mode allows you to disable the refrigerator and keep the freezer working.
	LED interior lighting: is a more energy efficient and long lasting way of illuminating the interior of the appliance.		Inverter technology: The evolution of Smeg's driers towards more intelligent and environmentally sustainable models has led to the choice of using Inverter technology with heat pumps, which reduces significantly energy consumption.
	Air plus: keeps food fresher for longer.		Sabbath: This function allows you to cook food during the Sabbath, the Holiday of rest in the Jewish religion, respecting the precepts.