

# SPR24UIMX

Range size	24"
Oven energy source	Electricity
Cooktop type	Induction
Main oven	Thermo-ventilated
Cleaning system - Main oven	VaporClean
EAN code	8017709332341



## Aesthetic



Series	Professional	No. of controls	2
Color	Stainless steel	Display	Touch
Finishing	Satin	Handle	Robust knurled handle
Control panel finish	Stainless steel	Handle color	Brushed stainless steel
Cooktop color	Stainless steel	Feet	Stainless steel
Control knobs	Pro-style control knobs		

## Programs / Functions

No. of cooking functions 8

### Traditional cooking functions

Static	Fan-assisted	True European convection
Small grill	Large grill	Large grill + Fan
Convection bottom	Pizza	

### Other functions

Defrost by time

### Cleaning functions

VaporClean

## Cooktop options



End cooking timer	4	Limited power consumption option	Yes
Minute minder	1	Multizone Option	Yes

## Cooktop technical features



<b>Cooking zones 4</b>			
Front-left - 1300 W - Booster 1400 W - Ø 18.0 cm			
Rear-left - 2300 W - Booster 3000 W - Ø 18.0 cm			
Front-right - 2300 W - Booster 3000 W - Ø 14.5 cm			
Rear-right - 1300 W - Booster 1400 W - Ø 21.0 cm			
<b>Number of Flexible zones</b>	1	<b>Automatic pan detection</b>	Yes
<b>Booster power left Multizone</b>	3700 W	<b>Minimum pan diameter indicator</b>	Yes
<b>Automatic switch-off in case of over-heating</b>	Yes	<b>Selected zone indicator</b>	Yes
<b>Automatic switch-off in case of overflow</b>	Yes	<b>Residual heat indicator</b>	Yes

## Main Oven Technical Features



<b>No. of lights</b>	1	<b>Total no. of door glasses</b>	3
<b>Fan number</b>	1	<b>Cooling system</b>	Tangential
<b>Volume</b>	2.79 cu. ft.	<b>Bottom heating element - Power</b>	1200 W
<b>Cavity material</b>	EverClean enamel	<b>Upper heating element - Power</b>	1000 W
<b>No. of shelves</b>	5	<b>Grill power</b>	1700 W
<b>Light type</b>	Halogen	<b>Large grill - Power</b>	2700 W
<b>Light Power</b>	40 W	<b>Circular heating element - Power</b>	2000 W
<b>Time setting</b>	Minute minder	<b>Grill type</b>	Electric
<b>Removable door</b>	Yes	<b>Soft Close system</b>	Yes
<b>Removable inner door</b>	Yes		

## Main oven options

<b>Minimum Temperature</b>	151 °F	<b>Maximum temperature</b>	500 °F
----------------------------	--------	----------------------------	--------

## Accessories included for main oven and cooktop

Oven wire rack 2

## Electrical Connection

Plug	(B) NEMA 14-50P	Type of electric cable installed	Yes, Double phase
Circuit breaker	40 A	Power cord length	47 1/4 "
Voltage	208/240 V	Frequency	60 Hz

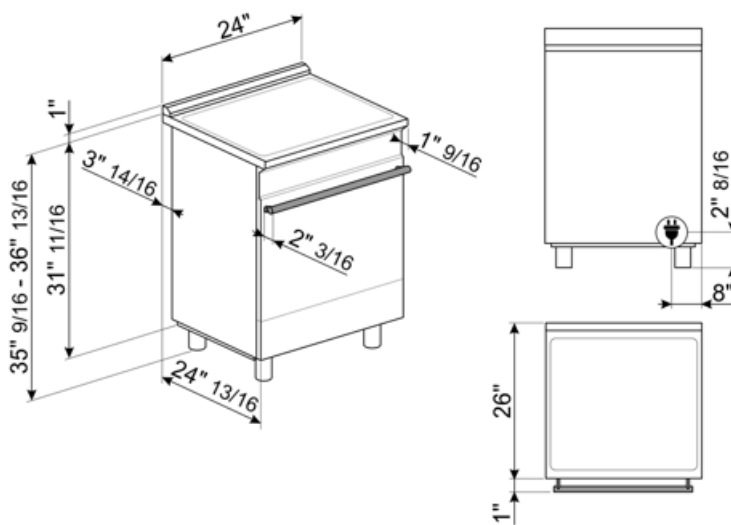

---

## Not included accessories

---



### GRM

Gas hobs moka support



### KITTKSPR24

Plinth, 3 sides, 900mm , SPR cookers 24", black



### PRTX

Refractory pizza stone with handles. D=35cm Not suitable for microwave ovens. Suitable for gas ovens, to be put on the griddle.



### SFLK1

Child lock



### GTP

\*\*Partial-extension telescopic guides\*\* Length: 14" Extraction: 11 1/4" Material: Stainless steel AISI 430 polished



### PALPZ

Pizza shovel with fold away handle width: 315mm length : 325mm



### SCRP



















Induction and ceramic hobs and teppanyaki scraper











### WOKGHU

Cast-Iron WOK Support

## Symbols glossary (TT)

 <p>Automatic merge of zones for a bigger area</p>	 <p>Installation in column: Installation in column</p>
 <p>Air cooling system: to ensure a safe surface temperatures.</p>	 <p>Defrost by time: with this function the time of thawing of foods are determined automatically.</p>
 <p>Triple glazed doors: Number of glazed doors.</p>	 <p>ECO-logic: option allows you to restrict the power limit of the appliance real energy saving.</p>
 <p>Enamel interior: The enamel interior of all Smeg ovens have a special antacid lining which helps keep the interior clean by reducing the amount of cooking grease adhering to it.</p>	 <p>Circogas: In gas ovens the fan distributes the heat quickly and evenly throughout the oven cavity, avoiding flavour transfer when cooking a number of different dishes at the same time. In electric ovens this combination completes cooking more quickly of foods that are ready on the surface, but that require more cooking inside, without further browning.</p>
 <p>Fan with upper and lower elements: The elements combined with the fan aim to provide more uniform heat, a similar method to conventional cooking, so pre-heat is required. Most suitable for items requiring slow cooking methods.</p>	 <p>Upper and lower element only: a traditional cooking method best suited for single items located in the centre of the oven. the top pf the oven will always be hottest. Ideal for roast, fruit cakes, bread etc.</p>
 <p>True European Convection: The combination of the fan and circular heating element around it provides many benefits, including no preheat if cooking time is longer than 20 minutes, no flavor transfer when cooking different foods at the same time, lower energy consumption, and shorter cooking times. Suitable for all types of food preparations.</p>	 <p>Grill element: Using of grill gives excellent results when cooking meat of medium and small portions, especially when combined with a rotisserie (where possible). Also ideal for cooking sausages and bacon.</p>
 <p>Half grill: For rapid cooking and browning of foods. Best results can be obtained by using the top shelf for small items, the lower shelves for larger ones, such as chops or sausages. For half grill heat is generated only at the centre of the element, so is ideal for smaller quantities.</p>	 <p>Fan with grill element: The fan reduces the fierce heat from the grill, providing an excellent method of grilling various foods, chops, steaks, sausages etc. giving even browning and heat distribution, without drying out the food. The top two levels recommended for use, and the lower part of the oven can be used to keep items warm at the same time, an excellent facility when cooking a grilled breakfast. Half grill (centre portion only) is ideal for small quantities of food.</p>
 <p>Pizza function: The simultaneous operation of three elements ensures an optimum cooking facility when used with the Smeg pizza stone.</p>	 <p>Overheat protection: The safety system that automatically turns off the hob in case of overheating of the control unit.</p>
 <p>Induction: The work of these hobs is based on the principle of electromagnetic induction. The heat is generated directly in the bottom of the pan during its contact with the hob.</p>	 <p>The inner door glass: can be removed with a few quick movements for cleaning.</p>

- 
- |  |   |
|--|---|
|  Side lights: Two opposing side lights increase visibility inside the oven.  |  Overfill protection: The special overfill protection shuts down the stove in the presence of overflow of liquids. |
|  Indication of residual heat: After the glass ceramic hob is switched off the residual heat indicator shows which of the heating zones still remains hot. When the temperature drops below 60 ° C, the indicator goes out. |  The oven cavity has 5 different cooking levels.   |
|  Soft close: all models are equipped with advanced function of smooth closing of the door, which allows the device to close smoothly and quietly.  |  Timer: All ceramic hobs have a timer which automatically ends cooking after a preset time.                        |
|  Vapor Clean: a simple cleaning function using steam to loosen deposits in the oven cavity.  |  ...   |

## Benefit (TT)

---

### **True-convection**

The best cooking performances guaranteed by ventilated circular flow.

Multiple fans and heating elements guarantee the perfect aerodynamic heat flow, allowing homogeneous and quicker cooking inside the cavity.

### **Induction hob**

Induction offers fast cooking and precise temperature control

Through the use of suitable cookware, induction is easy to use and maintain, safe and responsive

### **Vapor Clean**

By inserting water into a recess at the bottom of the cavity, steam is generated, which softens the residue and facilitates its removal

By inserting water into a recess at the bottom of the cavity, steam is generated, which softens the residue and facilitates its removal.

### **Touch control**

Easy and intuitive timer setting with a single touch

### **Single turbine**

The oven has a fan equipped with a circular heating element allowing cooking with rotating heat

### **Isothermic Cavity**

The best cooking performance at the highest energy efficiency

### **Tangential cooling**

New cooling system with tangential fan and airflow from the door to the splashback

### **Soft close**

The door is equipped with a specific system for silent closing

### **Multilevel halogen light**

Internal halogen lighting on different levels guarantees excellent visibility

### **Adjustable height**

Cooker top flushed with the working area thanks to adjustable feet

### **Removable inner glass**

Internal door glasses are easily removable for complete cleaning

### **Multilevel cooking**

Several cooking levels allow maximum flexibility of use

### **Cold door**

During any function, the external door glass is cold, avoiding any risk of burns

### **AirFry (AIRFRY optional accessory)**

Lighter and tastier food thanks to airfry basket

### **BBQ (optional accessory)**

Barbeque cooking directly in the oven with the double-sided grill

### **Pizza stone (optional accessory)**

Baking with refractory stone for soft and crispy pizza and yeast products (STONE optional accessory)