

SPR36UIMX

Range size	36"
Oven energy source	Electricity
Cooktop type	Induction
Main oven	Thermo-ventilated
Cleaning system - Main oven	VaporClean
EAN code	8017709308971



Aesthetic



Series	Professional	Slider	Red
Design	Squared design	Control knobs	Pro-style control knobs
Color	Stainless steel	Controls color	Stainless steel
Front panel color	Stainless steel	No. of controls	7
Control panel finish	Stainless steel	Silkscreen color	Black
Logo	Assembled	Display	Touch
Logo position	Fascia below the oven	Handle	Robust knurled handle
Cooktop color	Stainless steel	Handle color	Brushed stainless steel
Control setting type	Control knobs		

Programs / Functions

No. of cooking functions 8

Traditional cooking functions

Static	Fan-assisted	True European convection
Small grill	Large grill	Large grill + Fan
Convection bottom	Pizza	

Other functions

Defrost by time

Cleaning functions

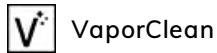

Cooktop options



End cooking timer	5	Multizone Option	Yes
Minute minder	1		

Cooktop technical features



Cooking zones 5

Front-left - 1300 W - Booster 1400 W
 Rear-left - 2300 W - Booster 3000 W
 Center - 2300 W - Booster 3000 W
 Rear-right - 1300 W - Booster 1400 W
 Front-right - 2300 W - Booster 3000 W

Cooking zones with Booster	5	Automatic switch-off in case of overflow	Yes
Number of Flexible zones	1	Automatic pan detection	Yes
Booster power left Multizone	3700 W	Minimum pan diameter indicator	Yes
Booster power right Multizone	3700 W	Selected zone indicator	Yes
Automatic switch-off in case of over-heating	Yes	Residual heat indicator	Yes

Main Oven Technical Features



No. of lights	2	Removable inner door	Yes
Fan number	2	Total no. of door glasses	3
Volume	4.45 cu. ft.	Cooling system	Tangential
Cavity material	EverClean enamel	Bottom heating element - Power	1700 W
No. of shelves	5	Upper heating element - Power	1200 W
Shelves type	Metal racks	Grill power	1700 W
Light type	Halogen	Large grill - Power	2900 W
Light Power	40 W	Circular heating element - Power	1550 W
Time setting	Minute minder	Grill type	Electric
Full-glass inner door	Yes	Soft Close system	Yes

Main oven options

Minimum Temperature 151 °F

Maximum temperature 500 °F

Accessories included for main oven and cooktop

Oven wire rack 2

Meat Probe 1

Electrical Connection

Plug (B) NEMA 14-50P
 Circuit breaker 50 A
 Voltage 208/240 V
 Type of electric cable installed Yes, Double phase

Power cord length 47 1/4 "
 Frequency 60 Hz
 Terminal block 3 pins

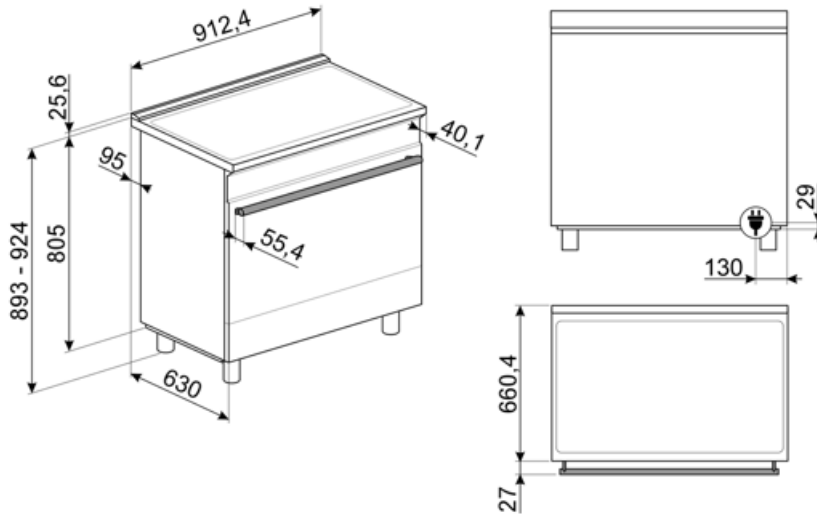

Not included accessories



GRILLPLATE

Universal griddle for induction, gas, ceramic and electric hobs. Non-stick surface ideal for cooking meat, cheese and vegetables. Dimensions: 410 x 240 mm.



KITTKSPR36

Plinth, 3 sides, 900mm , SPR cookers 30", black



PPR9

Refractory pizza stone without handles. Squared stone (HxWxD): 0.9" x 25.2" x 14.75". Also suitable for gas ovens, to be placed on a rack



SCRP

Induction and ceramic hobs and teppanyaki scraper



TPKPLATE

Universal plate for induction, gas, ceramic and electric hobs. Non-stick surface ideal for cooking fish, eggs and vegetables. Dimensions: 410 X 240 mm.



GT3T



PALPZ

Pizza shovel with fold away handle width: 315mm length : 325mm



PRTX



















Refractory pizza stone with handles. D=35cm Not suitable for microwave ovens. Suitable for gas ovens, to be put on the griddle.













SFLK1

Child lock

Symbols glossary (TT)

 <p>Automatic merge of zones for a bigger area</p>	 <p>Power booster: option allows the zone to work at full power when very intense cooking is necessary.</p>
 <p>Installation in column: Installation in column</p>	 <p>Air cooling system: to ensure a safe surface temperatures.</p>
 <p>Defrost by time: with this function the time of thawing of foods are determined automatically.</p>	 <p>Triple glazed doors: Number of glazed doors.</p>
 <p>Enamel interior: The enamel interior of all Smeg ovens have a special antacid lining which helps keep the interior clean by reducing the amount of cooking grease adhering to it.</p>	 <p>Circogas: In gas ovens the fan distributes the heat quickly and evenly throughout the oven cavity, avoiding flavour transfer when cooking a number of different dishes at the same time. In electric ovens this combination completes cooking more quickly of foods that are ready on the surface, but that require more cooking inside, without further browning.</p>
 <p>Fan with upper and lower elements: The elements combined with the fan aim to provide more uniform heat, a similar method to conventional cooking, so pre-heat is required. Most suitable for items requiring slow cooking methods.</p>	 <p>Upper and lower element only: a traditional cooking method best suited for single items located in the centre of the oven. the top pf the oven will always be hottest. Ideal for roast, fruit cakes, bread etc.</p>
 <p>True European Convection: The combination of the fan and circular heating element around it provides many benefits, including no preheat if cooking time is longer than 20 minutes, no flavor transfer when cooking different foods at the same time, lower energy consumption, and shorter cooking times. Suitable for all types of food preparations.</p>	 <p>Grill element: Using of grill gives excellent results when cooking meat of medium and small portions, especially when combined with a rotisserie (where possible). Also ideal for cooking sausages and bacon.</p>
 <p>Half grill: For rapid cooking and browning of foods. Best results can be obtained by using the top shelf for small items, the lower shelves for larger ones, such as chops or sausages. For half grill heat is generated only at the centre of the element, so is ideal for smaller quantities.</p>	 <p>Fan with grill element: The fan reduces the fierce heat from the grill, providing an excellent method of grilling various foods, chops, steaks, sausages etc. giving even browning and heat distribution, without drying out the food. The top two levels recommended for use, and the lower part of the oven can be used to keep items warm at the same time, an excellent facility when cooking a grilled breakfast. Half grill (centre portion only) is ideal for small quantities of food.</p>
 <p>Pizza function: The simultaneous operation of three elements ensures an optimum cooking facility when used with the Smeg pizza stone.</p>	 <p>Overheat protection: The safety system that automatically turns off the hob in case of overheating of the control unit.</p>
 <p>Induction: The work of these hobs is based on the principle of electromagnetic induction. The heat is generated directly in the bottom of the pan during its contact with the hob.</p>	 <p>All glass inner door: All glass inner door, a single flat surface which is simple to keep clean.</p>

-
- | | |
|--|---|
|  The inner door glass: can be removed with a few quick movements for cleaning. |  Side lights: Two opposing side lights increase visibility inside the oven. |
|  Overfill protection: The special overfill protection shuts down the stove in the presence of overflow of liquids. |  Indication of residual heat: After the glass ceramic hob is switched off the residual heat indicator shows which of the heating zones still remains hot. When the temperature drops below 60 ° C, the indicator goes out. |
|  The oven cavity has 5 different cooking levels. |  Soft close: all models are equipped with advanced function of smooth closing of the door, which allows the device to close smoothly and quietly. |
|  Timer: All ceramic hobs have a timer which automatically ends cooking after a preset time. |  Vapor Clean: a simple cleaning function using steam to loosen deposits in the oven cavity. |
|  ... |  Knobs control |

Benefit (TT)

True-convection

The best cooking performances guaranteed by ventilated circular flow.

Multiple fans and heating elements guarantee the perfect aerodynamic heat flow, allowing homogeneous and quicker cooking inside the cavity.

Induction hob

Induction offers fast cooking and precise temperature control

Through the use of suitable cookware, induction is easy to use and maintain, safe and responsive

Vapor Clean

By inserting water into a recess at the bottom of the cavity, steam is generated, which softens the residue and facilitates its removal

By inserting water into a recess at the bottom of the cavity, steam is generated, which softens the residue and facilitates its removal.

Touch control

Easy and intuitive timer setting with a single touch

Isothermic Cavity

The best cooking performance at the highest energy efficiency

Double Turbine

The oven has two fans equipped with two circular heating elements allowing cooking with rotating heat

Tangential cooling

New cooling system with tangential fan and airflow from the door to the splashback

Soft close

The door is equipped with a specific system for silent closing

Multilevel halogen light

Internal halogen lighting on different levels guarantees excellent visibility

Adjustable height

Cooker top flushed with the working area thanks to adjustable feet

Removable inner glass

Internal door glasses are easily removable for complete cleaning

Multilevel cooking

Several cooking levels allow maximum flexibility of use

Cold door

During any function, the external door glass is cold, avoiding any risk of burns

AirFry (AIRFRY optional accessory)

Lighter and tastier food thanks to airfry basket

BBQ (optional accessory)

Barbeque cooking directly in the oven with the double-sided grill

Pizza stone (optional accessory)

Baking with refractory stone for soft and crispy pizza and yeast products (STONE optional accessory)